

User Guide – MODBUS protocol

**Firmware Version:
 DAT9000USB-2.0: 9BB4
 DAT9000DL-2.0: 9BB4
 DAT9000: 9BB0**

**DAT9000USB-2.0
 DAT9000DL-2.0
 DAT9000**

All the data shared by a device communicating by Modbus RTU / Modbus TCP protocol are mapped in tables where in to each data is associated a determined address.

Each data could be of two types:

- "REGISTER", data of 2 bytes size (word of 16 bits) that can be associated to analogue input or output, variables, set-point, etc...
- "COIL", data of 1 single bit that can be associated to digital input or output or to a logic state.

A register could contain the image (mirror) of more coils; in example the 16 digital inputs of a device could be read or written as bit (singularly) addressing the coil related to each input or can be read or written as a single word addressing the associated register wherein each bit corresponds to a coil.

In the Modbus protocol, registers and coils are divided as per the following groups of addresses:

0xxxx and 1xxxx = Coils (bit)

3xxxx and 4xxxx = Registers (word)

When addressing the registers when functions of reading and / or writing of registers and coils are used, use the tables shown below, adding 1 if the device is polled by external unit.

The module's internal registers can be accessed via direct Modbus RTU or Modbus TCP command.

REGISTERS TABLE

Register	Description	Access
0	Status	RO
1	Firmware Version	RO
2		RO
3	Name	R/W
4		R/W
5	Port 1 Set (RS485 Master)	R/W
6	Address	R/W
7	Port 1 Timeout	R/W
8	--Reseved--	RO
9	--Reseved--	RO
10	System Flags	R/W
11	--Reserved--	RO
12	WatchDog Time	R/W
13	--Reserved--	RO
14	--Reserved--	RO
15	Reset Timers	RO
16	COM Errors	R/W
17	Gateway Mask [L-H]	R/W
18	Port 0 Set (RS485 Slave)	R/W
19	Port 2 Set (uUSB Slave)	R/W
20	Timers Enable	R/W
21	--Reserved--	RO
22	RTC[Sec]	RO
23	RTC[Min/Hours]	RO
24	RTC[Day/Date]	RO
25	RTC[Month/Year]	RO
26+34	--Reserved--	RO
35+926	General Purpose (RAM)	R/W
927+959	--Reserved--	R/W
960+1023	General Purpose (RAM)	R/W
1024+1025	--Reserved--	RO
1026	Ethernet. Comm. Slave Status	RO
1027	--Reserved--	RO
1028+1045	Buffered RAM	R/W
1046+1048	--Reserved--	RO
1049+1215	General Purpose (RAM)	R/W
1216+1223	--Reserved--	RO
(*)1224+1279	Retentive Registers (EEPROM)	R/W

COILS TABLE

Coil (Hex)	Coil (Dec)	Description	Access
0x00A0	00160	Watch-dog Enable	R/W
0x00A1	00161	Watch-dog Event	R/W
0x00A2	00162	Power-Up Event	R/W

SUPPORTED MODBUS FUNCTION CODES

Function	Description
01	Read Coil Status (0xxxx)
02	Read Inputs Status (1xxxx)
03	Read Holding Registers (4xxxx)
04	Read Inputs Registers (3xxxx)
05	Force Single Coil
06	Preset Single Register
15 (0F)	Force Multiple Coil
16 (10)	Preset Multiple Registers

NOTES:

The registers and coils marked in the 'Access' column with the words RO are read-only registers (Read Only).

The registers and coils marked in the 'Access' column with the words R / W are read and write registers (Read / Write).

(*) Pay attention to the use of retentive registers in EEPROM (1224-1279) as they can not be written continuously.

Functions 01, 02 and 15 support reading and writing up to a maximum of 32 consecutive coils

The maximum number of registers that can be read through Modbus functions 03 and 04 (see "Supported modbus functions codes") are: 64

The maximum number of registers that can be written by Modbus function 16 (see "Supported modbus functions codes") are: 64

DESCRIPTION MODBUS REGISTERS

%R0 (40001) : STATUS

This read-only register indicates the device status. The values that this registry takes are:

Stop → 101

Halt / Step → 102

In all other cases (Debug, Run, Release and Animate) → 255

%R1/%R2 (40002 / 40003) : FIRMWARE VERSION

Field of 2 read-only registers, which contains the firmware identifier given by the manufacturer.

- Manufacturer's default: 9BB4 (ASCII)

%R3/%R4 (40004 / 40005) : NAME

Field of 2 registers (4 bytes or 4 ASCII characters) available to the user, can contain the name of the device or an acronym that identifies the function within the system. Each of the 4 bytes can contain any value from 0 to 255, thus also ASCII characters.

The default value of this field contains the module identifier in ASCII characters.

- Manufacturer's default: "9000" (ASCII).

%R5 (40006) : PORT 1 SET (RS485 Master)

In the lower part of this register it is possible to set the communication parameters (baudrate, parity and stop bit) relative to the serial port RS485 Master (Port 1).

- Manufacturer default: 38400 bps, parity NONE, stop bit 1

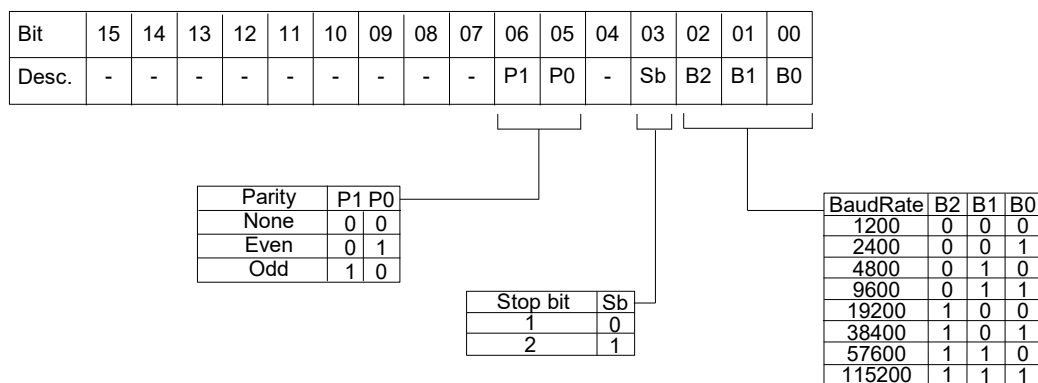

%R6 (40007) : ADDRESS

Contains the Modbus address of the module; addresses from 1 to 249 are allowed.

Each module connected to the same network must have a unique address.

- Manufacturer's default: 10

%R7 (40008) : PORT 1 TIMEOUT

Indicates the value of the time within the device must wait for the answer from the slave devices connected to its RS485 Master port (Port 1).

Beyond this time, any answers that arrive will be ignored.

This value is expressed in milliseconds.

- Manufacturer's default: 100

%R10 (40011) : SYSTEM FLAGS

Contains the enable bits and system events of the device. The following parameters are configurable:

WATCHDOG ENABLE

Enables the WatchDog alarm. If the alarm is enabled and the device doesn't receive commands for a time higher than the one specified in register %R12 (40013), the WatchDog Alarm will be activated (refer to section "Procedures").

0 = Watchdog disabled.

1 = Watchdog enabled.

WATCHDOG EVENT

Indicates the state of the WatchDog Alarm. If the alarm is enabled and the device doesn't receive commands for a time higher than the one specified in register %R12 (40013), this bit is forced to 1. To erase the alarm set this bit to 0. If the bit is forced to 1 by a command of the Master unit, a Watchdog event will be simulated and consequently an alarm condition will be created.

0 = Normal condition

1 = Alarm condition

POWER-UP EVENT

This bit is forced to 1 each time the device is powered-on in order to indicated that the device has been switched-off or a reset is occurred. By the set of this bit to 0 and check its state it is possible to monitor if a reset of the device is occurred.

0 = reset not occurred

1 = reset not occurred

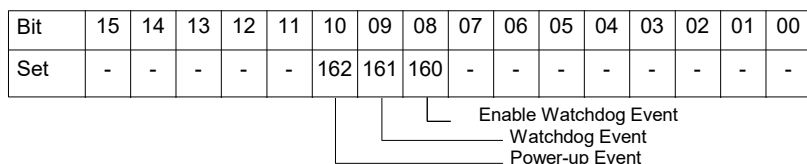

%R12 (40013) : WATCHDOG TIMER

Contains the value of the WatchDog timer expressed in seconds. If the WatchDog is enabled and the module does not receive commands for a time equal to the value contained in this register, the WatchDog alarm is triggered (see description in the "Procedures" section). The device return back from the alarm at the first command has been received.

- Manufacturer's default: 10 (10 sec)

%R15 (40016) : RESET TIMERS

Each bit of this register is associated with the reset of the relative internal timer (register %R20). If the bit relative to a specific timer is set to 1 while it is active and before it reaches the end of the countdown, the timer count is resetted and restarts from 0 msec. The reset timer bit will be automatically reset by the system.

Bit	15	14	13	12	11	10	09	08	07	06	05	04	03	02	01	00
Descr.	Reset Timers															
# Timer	T7	T6	T5	T4	T3	T2	T1	T0	T15	T14	T13	T12	T11	T10	T9	T8

%R16 (40017) : COM ERRORS

Counter of communication errors on the Master port. The value of this register is incremented each time a Modbus command is sent to the master port and no response is received.

%R17 (40018) : GATEWAY MASK [L-H]

In this register it is possible to specify the range of modbus addresses that the controller can consider as valid in relation to the commands sent through its own Master port when used as a Gateway. When the controller operates as a gateway and it is in stop condition, if it sends queries to a device whose address is not included in the mask, the command will be ignored. This register, appropriately configured, can eliminate echo problems on the RS485 network. The Gateway Mask is ignored if the addresses are interrogated directly by the controller through an internal project.

- Manufacturer's default: 255 (00FF Hex)

Bit	15	14	13	12	11	10	09	08	07	06	05	04	03	02	01	00
Descr.	Initial Address Mask								Final Address Mask							

%R18 (40019) : PORT 0 SET (RS485 Slave)

%R19 (40020) : PORT 2 SET (uUSB)

In the upper part of this register it is possible to set the communication parameters (baudrate, parity and stop bit) relative to the serial port RS485 Slave (Port 0) and of the virtual serial port uUSB Slave (Port 2). The communication parameters are common for both slave ports (Port 0 and uUSB).

Warning: the uUSB port and the RS485 slave port (Port 0) cannot be used simultaneously.

The lower part of the register is reserved for the Delay RX / TX of the slave port and indicates the time delay that the device waits before transmitting the response to the connected master unit. The value can be between 1 and 255 and is expressed in milliseconds.

- Manufacturer default: 38400 bps, parity NONE, stop bit 1, Delay RX / TX slave 1

Bit	15	14	13	12	11	10	09	08	07	06	05	04	03	02	01	00
Descr.	-	P1	P0	-	Sb	B2	B1	B0	Delay RX/TX							

Parity	P1	P0
None	0	0
Even	0	1
Odd	1	0

Stop bit	Sb
1	0
2	1

BaudRate	B2	B1	B0
1200	0	0	0
2400	0	0	1
4800	0	1	0
9600	0	1	1
19200	1	0	0
38400	1	0	1
57600	1	1	0
115200	1	1	1

WARNING! To communicate through the uUSB Slave port (Port 2) it is mandatory to use the supplied CVPROG cable.

The CVPROG cable is not a common USB-uUSB cable but has a chip inside it that generates a virtual port on your PC.

%R20 (40021) : TIMERS ENABLE

Each bit of this register is associated to an internal timer. The timer starts to count when the relative bit is set to 0. After the time specified for the timer has expired (through the proper Function Block in Dev9k), the same bit is automatically forced to 1, indicating that the timer has expired.

Bit	15	14	13	12	11	10	09	08	07	06	05	04	03	02	01	00
Descr.	Timers															
# Timer	T7	T6	T5	T4	T3	T2	T1	T0	T15	T14	T13	T12	T11	T10	T9	T8

%R22 (40023) : RTC[Sec]

%R23 (40024) : RTC[Min/Hours]

%R24 (40025) : RTC[Day/Date]

%R25 (40026) : RTC[Month/Year]

Field of 4 read/write Registers: contain the value of the internal clock.

The following information are available:

Seconds	00 ÷ 59
Minutes	00 ÷ 59
Hours	00 ÷ 23
Day of week	01 ÷ 07 (01=Sunday, 02=Monday, 07=Saturday)
Date	01 ÷ 31 (it depends on the month)
Month	01 ÷ 12 (01=January, 02=February, 12=December)
Year	00 ÷ 99 (00=2000, 99=2099)

Bit	15	14	13	12	11	10	09	08	07	06	05	04	03	02	01	00
%R22	---								Seconds [0÷59]							
%R23	Minutes [0÷59]								Hours [0÷23]							
%R24	Day of week [1÷7]								Date [1÷31]							
%R25	Month [1÷12]								Year [0÷99]							

NOTE: all of the values are written as hexadecimal characters .

NOTICE! Writing these Registers will imply the variation of the clock and calendar settings.

%R35 (40036) → %R926 (40927) : General Purpose (RAM)
%R960 (40961) → %R1023 (41024) : General Purpose (RAM)
%R1049 (41050) → %R1215 (41216) : General Purpose (RAM)

These three blocks of registers are areas of RAM that can be used by the user for the construction of their projects. The user, through these registers can perform mathematical operations, logical operations or store data from external devices with the use of specific modbus functions (reading, writing). These registers can be written continuously.

ATTENTION: these registers reside in the RAM memory therefore, in the absence of power supply to the device, the contained values will be lost.

%R1026 (41027): Ethernet Comm. Slave Status

This register indicates which of the slave devices inserted in the IP table does not communicate (Modbus TCP protocol).

Each bit corresponds to a device in the same position in the IP table.

- If the bit = 1 → the device not communicates
- If the bit = 0 → the device communicates or there isn't in the IP table

Bit	15	14	13	12	11	10	09	08	07	06	05	04	03	02	01	00
Device	-	-	-	-	-	-	-	-	#7	#6	#5	#4	#3	#2	#1	#0

→ Position in the IP table:
Device 0 → bit 0 → position 0

%R1028 (41029) → %R1045 (41046) : Buffered RAM

These registers reside in an area of RAM memory that is powered by the internal buffer battery, which is why they are called "Buffered".

They are like the registers in RAM General Purpose but, in case of absence of power supply to the device, the contained value is not lost because it is maintained by the internal battery. These registers can be written continuously.

%R1224 (41225) → %R1279 (41280) : Retentive Registers (EEPROM)

These registers reside in EEPROM and therefore called retentive. In case of a power supply failure, the value contained in these registers will not be lost. They are often used to store constants that are used in several function blocks during the making of the project by the Dev9k software or to store values that must be not continuously changed (from a SCADA, HMI or PLC).

ATTENTION: these registers reside in the EEPROM memory therefore they can not be used to be written continuously. If this happens, the EEPROM would be irreparably compromised because limited cycles of writing are allowed.

HOW TO CONNECT IN INIT MODE

USING THE "INIT" FUNCTION

All DAT9000 series devices are equipped with the INIT mode. This is a mode to access the device with the default parameters and then to configure it:

Over Ethernet:

- IP Address: XXX.XXX.XXX.XXX provided by the DHCP if is enabled or 192.168.1.174 if DHCP is disabled (verify that the IP is not already used and that the PC belongs to the same subnet)
- Modbus address: 10

By these parameters it is possible to access the device in INIT mode to configure it or see the stored configuration.

To enter INIT, follow the procedure below:

- Turn off the device;
- Connect the INIT terminal to the -V terminal as shown in the technical datasheet of the device.
- Turn on the device;
- Connect to the device using the default parameters shown above.

When the user finishes working in INIT mode:

- Turn off the device;
- Remove the INIT connection;
- Turn on the device and connect with the parameters known or configured in INIT mode.

Over RS485 slave or uUSB:

- Switch off the device.
- Connect only the device to be programmed to the RS485 slave or uUSB network.
- Connect the INIT terminal to terminal V-.
- Turn on the device.

- Set the communication port with the following values

Mode = Modbus RTU

baud-rate = 9600 bps

parity = None

bit number = 8

stop bit = 1

- The form answers at address 10.
- Read or program the desired settings in the registers using the Dev9k software.
- Switch off the device.
- Disconnect the INIT terminal from terminal V-.
- Set the communication port with the programmed baud-rate
- The module answers with the programmed address

WATCHDOG

The modules of the DAT9000 series are provided with the Watchdog timer which, if enabled, triggers an alarm every time the communication between the module and the master remains inactive for a time longer than the specified one.

During the Watchdog alarm state, the green "PWR" LED on the front of the module starts to flash and the "Watchdog Event" coil is set to 1. To exit the alarm condition, send any command to the device and reset the "Watchdog Event" coil.

FUNCTION BUTTON "P"

In case of necessity, the "P" button allow to the user to recover the "Factory parameters" in to the device.

With the device on and not in INIT condition, press the button "P" located on the front for at least 5 seconds;

The green led PW will switch-off, the led STS will become orange and the reset of the device will occur (modbus parameters, default IP, login credentials to the web server).

When the reset is finished, both LEDs will return to the default state condition for which the following parameters will be loaded:

Ethernet:

- IP Address: 192.168.1.100
- Subnet Mask : 255.255.255.0
- Gateway Mask: 192.168.1.1

Modbus:

- Address : 10
- Baud Rate Port 1: 38400 bps
- Baud Rate Port 0 and Port 2: 38400 bps

Login:

- Username: Fact_user
- Password: Fact_pwd

ATTENTION: do not switch off the device during the loading phase!

INTERFACE CABLE "CVPROG"

Description

The CVPROG cable is an interface consisting of the physical cable, a uUSB port that must be connected to the DATEXEL device in use, a USB port that must be connected to the user PC and a chip to recognize the USB port as VCP (Virtual Com Port).

Due to this the CVPROG interface cable is not a simple uUSB-USB cable.

Through the CVPROG cable it is possible to communicate and program the DATEXEL devices without external power.

This allows a simple use of the device.

WARNING: the uUSB port and the RS485 slave port (Port 0) cannot be used simultaneously and the communication parameters are common to both ports.

When connecting the CVPROG cable to the PC, it will be necessary to install the drivers supplied with the CDROM supplied with the device or downloaded from the website www.datexel.it

Verify of the generated COM port

When the CVPROG cable is inserted into the PC, a virtual COM port is automatically generated and it can be displayed in the "Device Management" window → Ports (COM and LPT) of the operating system in use.

Factory uUSB port parameters (not INIT mode)

Baud rate: 38400 bps

N°bit: 8

Parity: None

Stop bit: 1

SEARCH FOR A DEVICE IN THE NETWORK

The DAT9000 series devices have the default IP address 192.168.1.100 and modbus address 10.
The PC can work with multiple subnets.

Note: To find the controller, the PC and the DAT9000 series device must be part of the same subnet.



Fig. 1

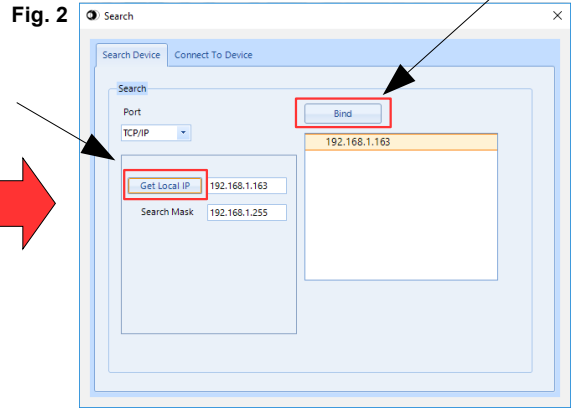

Fig. 2

Please follow this procedure to connect to DAT9000 device:

- 1) Run the Dev9k 2.0 and click on the "Connect" button in the Home Page (Fig. 1)
- 2) Check if the IP address of device is in the same subnet of the PC.
Click on "Get Local IP" button to display the PC IP address (Fig. 2)
- 3) In the area under the "Bind" button, the networks available on PC are displayed.
Select, if listed, the linked network to which the IP address belongs.
- 4) Click on "Bind" button to set the network to search for the device (Fig. 2)
- 5) Click on "Search" button to search the device in the network (Fig. 3)
- 6) Select the IP address of the controller, press the right mouse button and select "Set as Controller" to connect to the desired device.
- 7) When the message box "Connected" appears, click on "OK".

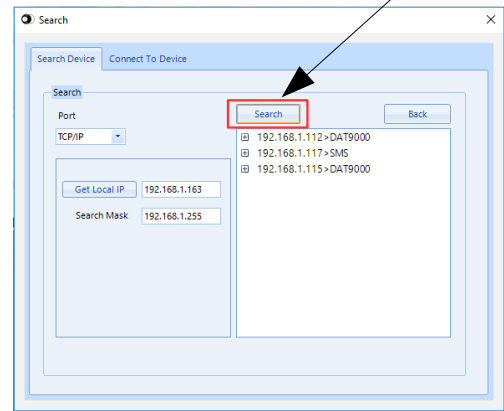

Fig. 3

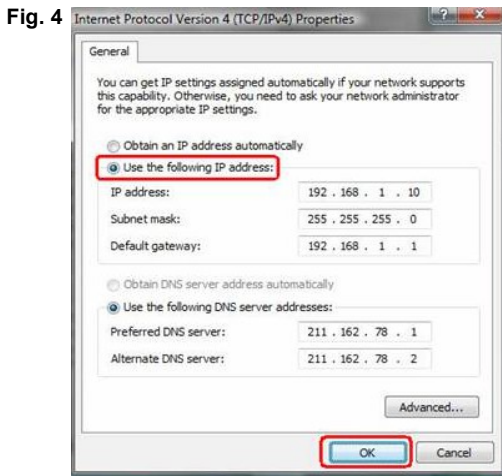

Fig. 4

If the device does not belong to the same subnet of the PC, in order to change the IP of the product, first change the IP of the Personal Computer so that the device belongs to the same subnet of the PC.

To do this, open the "Network and Sharing Center" section of the operating system in use, go to the PC IPV4 network properties window (Fig. 4) and configure the network parameters compatibly with the default IP of the device: (see section "Examples for Windows® configurations")

IP Address: 192.168.1.XXX; modbus address (xx)
Subnet Mask: 255.255.255.0
Gateway Mask: 192.168.1.1

After carrying out the previous operations, the DAT9000 device can be searched on the network and it is possible to change the IP address with the desired one, which must be different from the other IPs used in the network.

To change the device IP address and the other network parameters, follow the procedure below:

1. Connect to the device (point from 1) to 7) of the previous procedure)
2. In the menu bar, click on *Tools* → *Config*, it will appear the box in figure below (Fig. 5)
3. Click on the tag "Ethernet" and change the network parameters (Fig. 6)
4. Click on  to edit the parameters (Fig. 6)

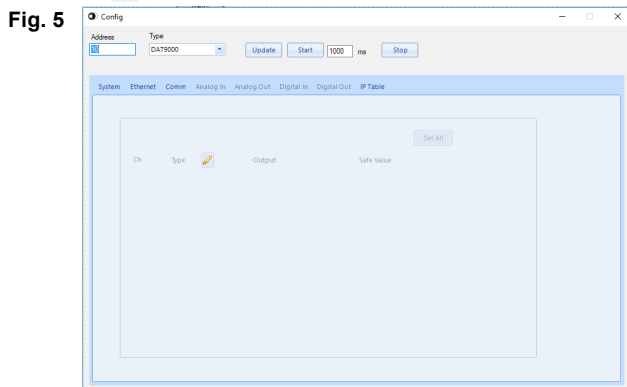

Fig. 5

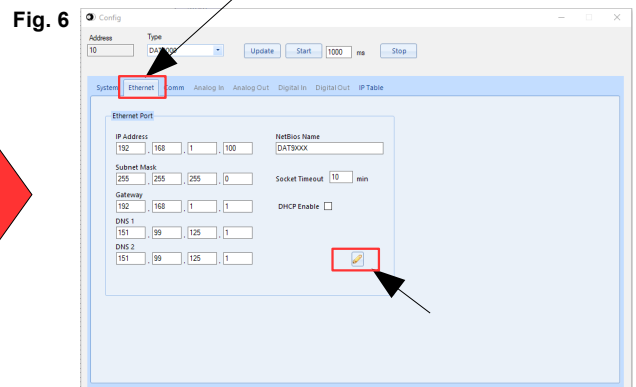

Fig. 6

Once the IP address of the Datexel device has been changed, it will no longer appear in the search results in the Dev9k. The user will then need to re-edit the PC network parameters to display the device again between the search results.

ADDITIONAL COMMANDS TO DETERMINE THE NETWORK IN USE

It is possible to use the following additional commands to determine to which network is connected the PC.

To use it run the command Prompt (cmd.exe) **as Administrator** in the Windows in use .

Command "ipconfig"

It is possible to visualize the nets used by the PC writing this command and press enter.

The system will return a list of all the nets used by the PC. Before to try to establish a communication with the device the user must be sure to be in the correct subnet (ref previous chapter).

Command "ping"

To determine if a device is connected on the net it is possible to use the "ping" command that is an utility for computer networks used to measure the time, in milliseconds, used by one or more packets to reach a network device and to return to the origin.

To use the command , type the command " ping " followed by the IP address of the device and press Enter .

Example:

ping 192.168.1.100

If the device is connected the system will return the answer from the device with the IP mentioned.

If the systems returns the message Host Unreachable the device is not connected in the net in use.

In this case it is suggested to check the network assignment.

EXAMPLE TO CHECK WINDOWS @ CONFIGURATION

How to change the IP address of the PC (each version of the operative system could change in part from others)

- Access to Control Panel of PC

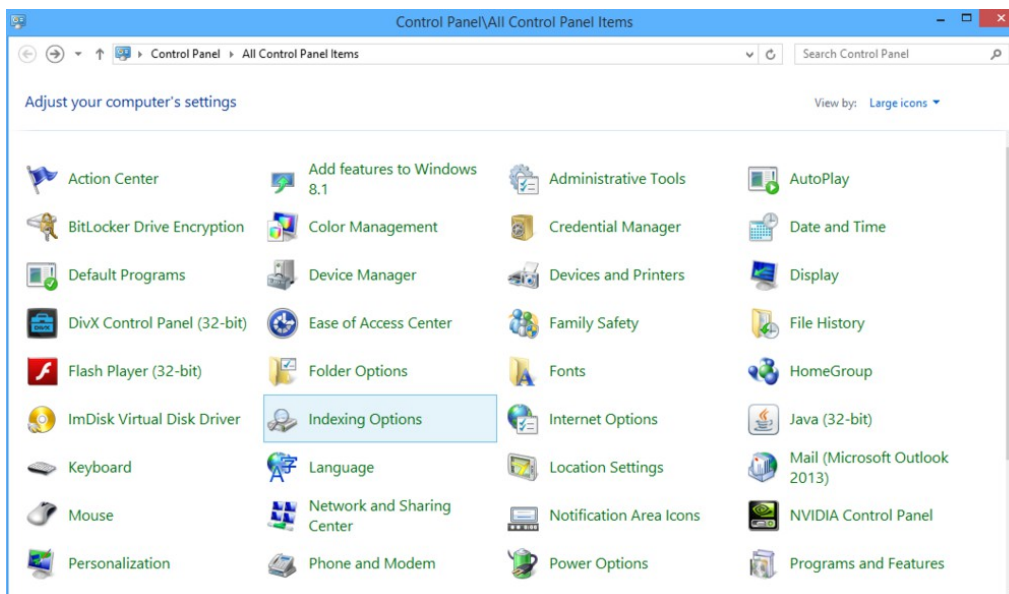

- Network and Sharing Center → Change Adapter Settings → select the interested network → right click → Properties → Internet Protocol version 4 → Properties.

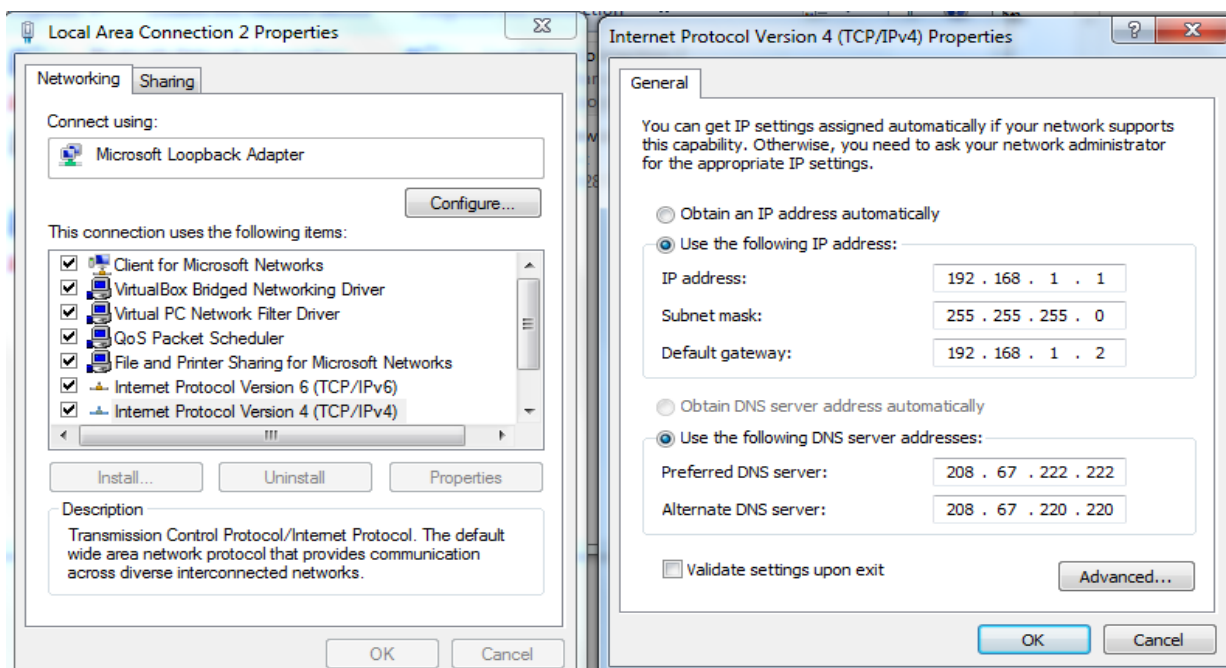

- Change parameters and click OK.

RIF. FW : 9BB4

RIF. FW : 9BB0

ED.01.20 REV.03