

# DAT 10016



## FEATURES

- Modbus Slave device on RS-485
- Modbus RTU/ Modbus ASCII protocol
- 4 input channels for voltage up to  $\pm 250$  mV and thermocouples sensor type B, E, K, J, N, R, S, T
- Communication parameters configurable by dip-switches
- Watch-Dog Alarm
- Remotely Configurable
- 1500 Vac 3-ways Galvanic Isolation
- LEDs of signalling on front side for power supply and communication
- Connection by removable screw terminals
- High Accuracy
- CE mark
- DIN rail mounting in compliance with EN-50022

## GENERAL DESCRIPTION

The device DAT10016 converts up to 4 analogue input signals into engineering units in digital format. The data are transmitted with MODBUS RTU / MODBUS ASCII protocol over the RS-485 network.

It is possible to connect on input 4 voltage signals up to  $\pm 250$  mV or thermocouples sensor type B, E, K, J, N, R, S, T. By programming, it is possible to execute the scaling of the measure of input up to  $\pm 32768$  points obtaining in the dedicated registers the measure of the channel in the desired format (ref. User Guide). The device guarantees high accuracy and stable measure versus time and temperature.

To ensure the plant safety, a Watch-Dog timer alarm is provided.

The isolation between the parts of circuit removes eventual ground-loop effects, allowing the use of the device even in the heavy environmental conditions.

The device is housed in a 6 module DIN rough self-extinguishing plastic box for mounting on EN-50022 standard DIN rail.

## COMMUNICATION PROTOCOLS

The device is designed to work with the MODBUS RTU/MODBUS ASCII protocol: standard protocol in field-bus; allows to directly interface DAT10000 series devices to the larger part of PLCs and SCADA applications available on the market.

For the protocol instructions, refer to the User Guide of the device.

## USER INSTRUCTIONS

Before to install the device, please read the "Installation Instruction" section.

It is possible to configure the device in two modes: by the dip-switches located on the front of the device or via software using the INIT modality.

Connect the terminal INIT to the terminal REF; at the power-on the device will be automatically set in the configuration set-up (refer to the User Guide of the device).

Connect power supply, serial bus and analogue inputs as shown in the "Wiring" section.

The LEDs state depends on the working condition of the device: see the "Light Signalling" section to verify the device working state.

To perform configuration and calibration operations, read the instructions in the User Guide of the device.

To simplify handling or replacing of the device, it is possible to remove the wired terminals even with the device powered.

## TECHNICAL SPECIFICATIONS (Typical @ 25 °C and in the nominal conditions)

| INPUT               |         |          | Input Accuracy (1)<br>mV, TC  | > of $\pm 0.05\%$ f.s.<br>or 5 $\mu$ V  | POWER SUPPLY<br>Power supply voltage 10 .. 30 Vdc<br>Reverse polarity protection 60 Vdc max<br>Current consumption (operative) 35 mA max@24Vdc<br>45 mA max@10Vdc   |
|---------------------|---------|----------|---|---|---|
| Input type          | Min     | Max      |   |   |   |
| <b>Voltage</b>      |         |          | <b>Linearity (1)</b><br>mV $\pm 0.1\%$ f.s.<br>TC $\pm 0.2\%$ f.s.  | <b>CJC Compensation</b><br>$\pm 1$ °C   | <b>ISOLATION</b><br>Between all the ways 1500 Vac,<br>50 Hz, 1 min  |
| 50 mV               | -50 mV  | +50 mV   |   |   |   |
| 100 mV              | -100 mV | +100 mV  |   |   |   |
| 250 mV              | -250 mV | +250 mV  |   |   |   |
| <b>Thermocouple</b> |         |          | <b>Input impedance</b><br>mV,TC $\geq 1$ M $\Omega$   | <b>Thermal drift (1)</b><br>Full scale $\pm 0.005\%$ / °C   | <b>ENVIRONMENTAL CONDITIONS</b><br>Operative Temperature -10°C .. +60°C<br>Storage Temperature -40°C.. +85°C<br>Humidity (not condensed) 0 .. 90 %<br>Maximum Altitude 2000 m<br>Installation Indoor<br>Category of installation II<br>Pollution Degree 2 |
| J                   | -210 °C | +1200 °C |   |   |   |
| K                   | -210 °C | +1372 °C |   |   |   |
| R                   | -50 °C  | +1767 °C |   |   |   |
| S                   | -50 °C  | +1767 °C |   |   |   |
| B                   | +400 °C | +1825 °C |   |   |   |
| E                   | -210 °C | +1000 °C |   |   |   |
| T                   | -210 °C | +400 °C  |   |   |   |
| N                   | -210 °C | +1300 °C |   |   |   |
|                     |         |          | <b>Thermal drift CJC</b><br>Full scale $\pm 0.02\%$ / °C  | <b>MECHANICAL SPECIFICATIONS</b><br>Material Self-extinguish plastic<br>IP Code IP20<br>Wiring wires with diameter 0.8+2.1 mm <sup>2</sup> /AWG 14-18<br>Tightening Torque 0.5 N m<br>Mounting in compliance with DIN rail standard EN-50022<br>Weight about 200 g. |   |
|                     |         |          | <b>Line resistance influence (1)</b><br>mV, TC $< 0.8$ $\mu$ V/Ohm  |   |   |
|                     |         |          | <b>Sample time</b> 0.5 + 1 sec.   |   |   |
|                     |         |          | <b>Warm-up time</b> 3 min.  | <b>CERTIFICATIONS</b><br><b>EMC ( for industrial environments)</b><br>Immunity EN 61000-6-2<br>Emission EN 61000-6-4  |   |
|                     |         |          | <b>Data Transmission (RS-485 asynchronous serial)</b><br>Baud Rate 115.2 Kbps<br>Max. distance 1.2 Km – 4000 ft |   |   |
|                     |         |          |   |   |   |

(1) referred to the input Span (difference between max. and min.)

## INSTALLATION INSTRUCTIONS

The DAT10016 is suitable for fitting to DIN rails in the vertical position. For optimum operation and long life follow these instructions:

**When the devices are installed side by side it may be necessary to separate them by at least 5 mm in the following case:**  
 - If panel temperature exceeds 45°C and power supply voltage 10 Vdc.

Make sure that sufficient air flow is provided for the device avoiding to place raceways or other objects which could obstruct the ventilation slits. Moreover it is suggested to avoid that devices are mounted above appliances generating heat; their ideal place should be in the lower part of the panel. Install the device in a place without vibrations.

Moreover it is suggested to avoid routing conductors near power signal cables (motors, induction ovens, inverters etc...) and to use shielded cable for connecting signals.

## WIRING

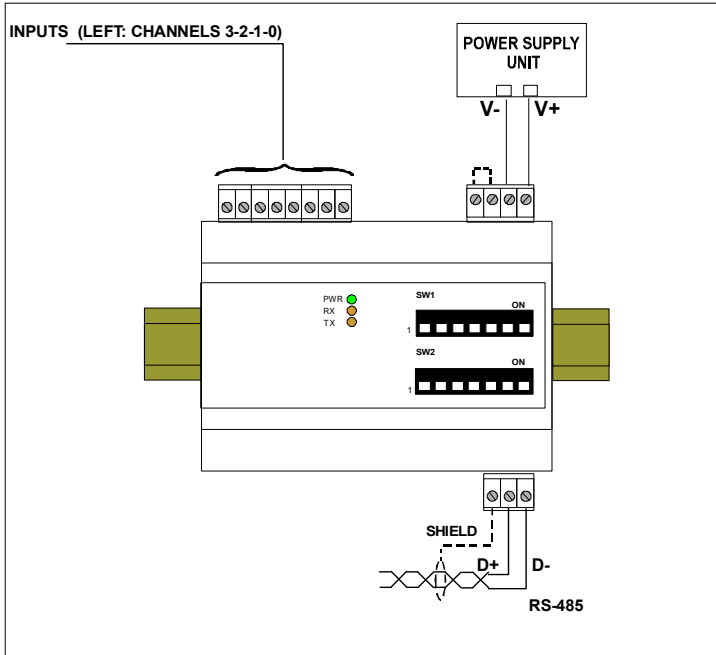

## LIGHT SIGNALLING

| LED | COLOUR | STATE | DESCRIPTION                                     |
|-----|--------|-------|---|
| PWR | GREEN  | ON    | Device powered                                  |
|     |        | OFF   | Device not powered                              |
|     |        | BLINK | ~1 sec. - Watch-Dog alarm condition occurred    |
| RX  | ORANGE | BLINK | Stream of data over receiving line of RS-485    |
|     |        | OFF   | No data over receiving line of RS-485           |
| TX  | ORANGE | BLINK | Stream of data over transmission line of RS-485 |
|     |        | OFF   | No data over transmission line of RS-485        |

## ISOLATION STRUCTURE



## MECHANICAL DIMENSIONS (mm)

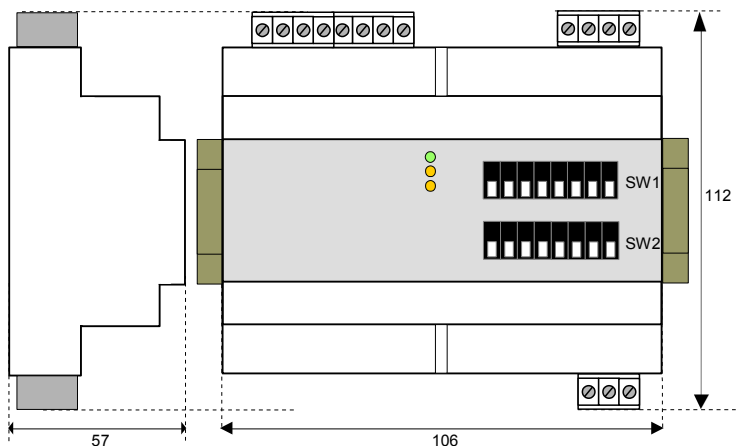

## CONNECTIONS

### ANALOGUE INPUTS

#### VOLTAGE

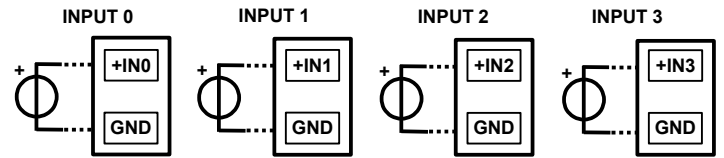

#### THERMOCOUPLES

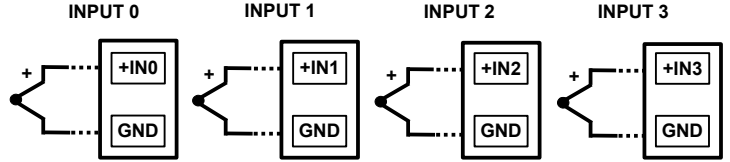

NOTE: the input channels are not isolated between them (terminal GND is common)

### SERIAL LINE RS-485

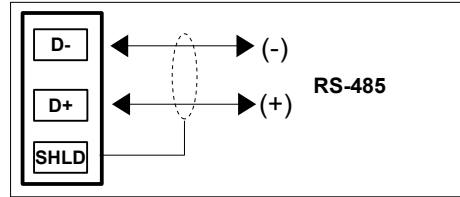

#### POWER SUPPLY

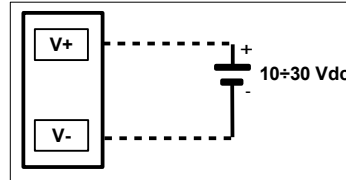

#### INIT

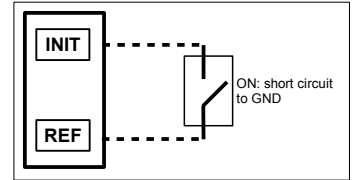

## DIP-SWITCHES : TABLES OF CONFIGURATION

Warning: set all the dip-switches in OFF position to access to the device in EEPROM modality (the device will follow all the communication parameters set by software) or INIT. Power-off the device before to change the set of the dip-switches.

TAB.1 Modality settings (Pos.1)

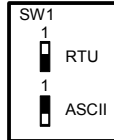

TAB.3 Baud rate settings (Pos.4 LSB; Pos.6 MSB)

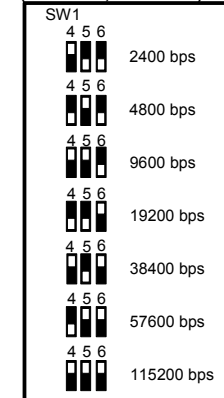

TAB.2 Parity settings (Pos.2 LSB; Pos.3 MSB)

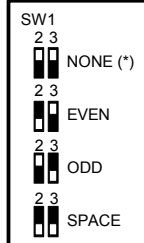

Note (\*):

- in Modbus RTU Modality the setting is NONE; number of bit = 8
- in Modbus ASCII Modality the setting is MARK; number of bit = 7

DIP POSITION



### HOW TO ORDER

The DAT10016 could be supplied as requested from the customer. Refer to the section "Technical Specifications" for the input type available.

**DAT 10016 / TCK** — Input type



The symbol reported on the product indicates that the product itself must not be considered as a domestic waste. It must be brought to the authorized recycle plant for the recycling of electrical and electronic waste. For more information contact the proper office in the user's city, the service for the waste treatment or the supplier from which the product has been purchased.

