



Voltage Trip Amp 1 Relay Output
Phone: +1 561 779 5660 E-mail : Info@datexel.com - Web Site www.datexel.com

FEATURES

- Available analogue inputs: RTD, TC, Voltage, Resistance and Current
- Two independent threshold programmable as both high alarm or one high and one low alarm
- Galvanic isolated among the three ways
- Trip level and hysteresis adjustable by potentiometer
- Delay time adjustable by potentiometer up to 25 sec.
- Two relays SPDT 250Vac, 2A
- High accuracy
- EMC compliant – CE mark
- Suitable for DIN rail mounting in compliance with EN-50022 and EN50035



GENERAL DESCRIPTION

The converter DAT 5024 is able to accept on its input a wide range of normalised voltage signals, normalised current signals coming from both active and passive current loop, signals coming from RTDs, Thermocouples and resistance sensors.

The input type and the input range are fixed: refer to the section "Technical Specifications", table "Input type" to order the device. The Threshold 1 is programmed as high alarm, while, by dip-switches, it is possible to set the Threshold 2 either as high or low alarm. The trip level of each threshold can be adjusted by the potentiometers and checked by the test-points located on the front of the device. It is possible to adjust by potentiometers also the values of the hysteresis level and delay time.

The isolations eliminate the effects of all ground loops eventually existing and allows the use of the converter in heavy environmental conditions found in industrial applications.

It is housed in a plastic enclosure of 20.5 mm thickness suitable for DIN rail mounting in compliance with EN-50022 and EN-50035 standards.

THRESHOLD OPERATION

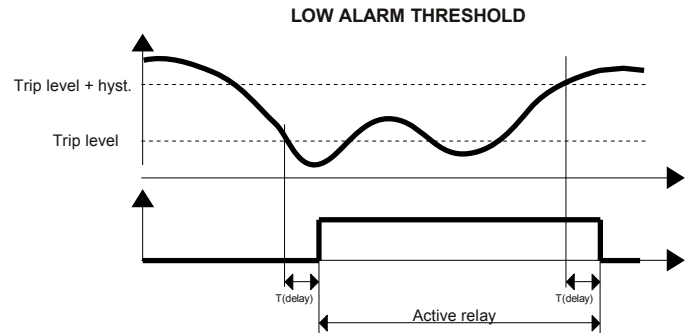
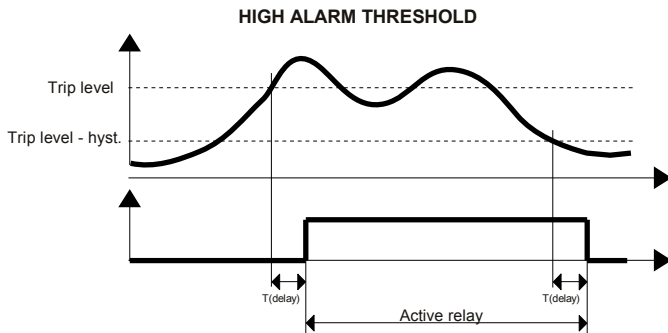

For the high alarm the relay goes on when the input signal is higher than the trip level and after the delay time. The relay goes off only when the input signal is lower than the trip level minus the hysteresis value or when reaches the minimum value of the input scale and after the delay time.

For the low alarm the relay goes on when the input signal is lower than the trip level and after the delay time. The relay goes off only when the input signal is higher than the trip level plus the hysteresis value or when reaches the maximum value of the input scale and after the delay time.

TECHNICAL SPECIFICATIONS (Typical at 25 °C and in nominal conditions)

Input type (*)	Min	Max	Input calibration (1)	Relays Output	N° 2 SPDT	
Voltage			$\pm 0.1\%$ f.s.	Contact rating	2A , 250 Vac	
50 mV	0 mV	+50 mV	Linearity (1)	Minimum load	2A , 30 Vdc	
100 mV	0 mV	+100 mV				5 Vdc, 10mA
250 mV	0 mV	+250 mV	Tc, RTD	Max Voltage	250 Vac (50/60 Hz)	
1000 mV	0 mV	+1000 mV	Input impedance	Isolation	coil-to-contacts: 2000Vac between contacts: 1000Vac	
10 V	0 V	+10 V				mV, Tc
Thermocouple	J	-210 °C	> 100 K Ω	Power supply	18 .. 32 Vdc	
	K	-210 °C	< 50 Ω			Power supply voltage
	R	-50 °C	+1200 °C	Current consumption	60 Vdc max	
	S	-50 °C	+1370 °C	Isolation voltage	Input – power supply	2000 Vac 50 Hz, 1 min.
	B	+400 °C	+1760 °C			
	E	-210 °C	+1820 °C	RTD excitation current	Power supply – contact of relay	1500 Vac 50 Hz, 1 min.
	T	-210 °C	+1000 °C	Typ. 0.6 mA	Environmental Conditions	Operative temperature
N	-210 °C	+400 °C	Thermal drift (1)	Storage temperature		
RTD	Pt100	-50 °C	Full Scale	Humidity (not condensed)	0 .. 90 %	
	Pt1000	-200 °C	$\pm 0.02\%$ / °C	Maximum Altitude	2000 m	
	Ni100	-60 °C	CJC comp.	Installation	Indoor	
	Ni1000	-60 °C	± 0.5 °C	Category of installation	II	
Resistance	250 Ω	0 Ω	CJC Thermal drift (1)	Pollution Degreee	2	
	2 K Ω	0 Ω	Full Scale	Mechanical Specifications		
Current	20 mA	20 mA	Line resistance influence (1)	Material	Self-extinguish plastic	
	20 mA	20 mA	mV, Tc	IP Code	IP20	
			Auxiliary supply	Wiring	wires with diameter	
			(only for mA input) > 18 V @ 20 mA	Tightening Torque	0.8*2.1 mm ² /AWG 14-18	
			(1) referred to input Span (difference between max. and min. values)	Mounting	0.8 N m	
			Threshold	in compliance with DIN		
			Adjustable from 2 up to 98% f.s.	rail standard EN-50022		
			Hysteresis	and EN-50035		
			Adjustable from 0.5 up to 10 % f.s.	about 100 g.		
			Delay	EMC (for industrial environments)		
			Adjustable up to 25 sec.	Immunity	EN 61000-6-2	
				Emission	EN 61000-6-4	

* Specify in phase of order

OPERATIVE INSTRUCTIONS

The converter DAT 5024 must be powered by a direct voltage included in the 18 V to 32 V range. The power supply must be applied between the terminals Q (+V) and R (-). The green led PWR switched on shows the right state of supply of the device, while the leds RL1 and RL2 switched on show the state of energizing of the relays relative to the threshold 1 (RL1) and the threshold 2 (RL2). The input connections must be made as shown in the section "Analogue input connections", in function of the device ordered; specify in phase of order the type of input and the input range.

The relays connections must be made as shown in the section "Contacts of relays"

To configure and calibrate the device refer to the section "Configuration".

To install the device refer to the section "Installation instructions".

CONFIGURATION

The trip levels are adjusted by the potentiometers "THR1" and "THR2" located on the front of the device; the delay time and the hysteresis value are the same for both the thresholds. Follow next steps in order to set the correct trip level value.

1- Refer to the section " Technical Specification ", table "Input type" and find the input type in use.

2 – Refer to the unit of measure of the input scale and calculate the voltage value corresponding to the threshold value using the next formula:

$$V = (\text{trip value} - \text{min}) / (\text{max} - \text{min})$$

where:

min: minimum value of the input type in use;

max: maximum value of the input type in use;

trip value: threshold value expressed in the unit measure of input.

The obtained value, proportional with the input scale, must be included between 0 and 1 V (*).

3 – Connect a multimeter, selected as Volt, between the test points TP1 and REF. By the potentiometer "THR1", adjust the measure in order to obtain the calculated value in the step 2; with such operation the threshold 1 value has been adjusted. Repeat the same operation for the threshold 2 using the potentiometer "THR2" and the test point TP2 (referred to the test point REF).

4 – Open the door located on the side of device.

5 – Set the type of alarm (high or low) for the threshold 2 by the DIP-switch "SW1".

6 – Adjust the delay time value (**) by the dedicated potentiometer as indicated in the section "Dimensions and regulations".

7 – Adjust the hysteresis(***) level by the dedicated potentiometer as indicated in the section "Dimensions and regulations".

NOTES:

(*)The maximum threshold value is internally limited at 98 %, the minimum at 2 %; the values of de-energizing of the relays "Trip value + hysteresis" and "Trip value – hysteresis" are limited to not get over the limits of the scale of measure.

(**) The delay time value is the same for the energizing and de-energizing of the relay; the minimum time between these operation it's about 1 second (time to have a stable measure) .

(***)The minimum hysteresis level value is internally limited at 0.5 %.

DIMENSIONS (mm) & REGULATIONS

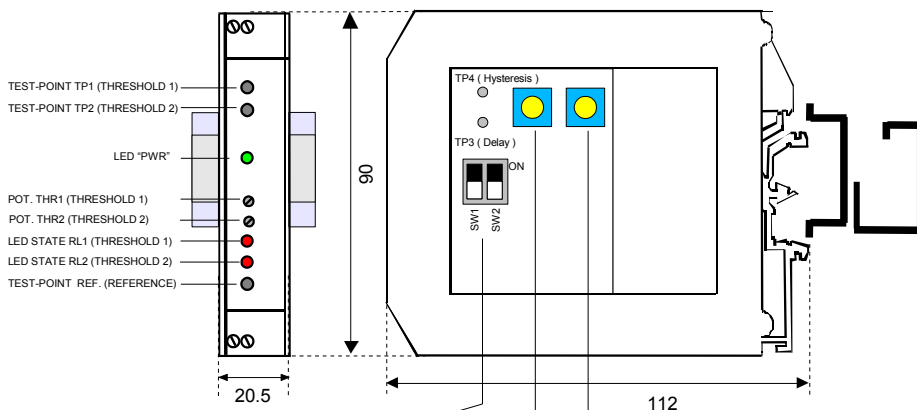

TYPE OF ALARM		
SW1	OFF	ON
ALARM 1	HIGH	HIGH
ALARM 2	HIGH	LOW

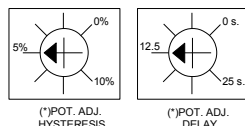

(*NOTE: FOR THE ROTATION DIRECTION AND THE ACTUAL POSITION OF REGULATION FOR THE CURSORS OF POTENTIOMETERS OF DELAY AND HYSTERESIS REFER TO THE LABEL POSITIONED ON THE REAR OF THE DOOR OF THE DEVICE.

INSTALLATION INSTRUCTIONS

The DAT 5024 device is suitable for fitting to DIN rails in the vertical position. For optimum operation and long life follow these instructions:

When the devices are installed side by side it may be necessary to separate them by at least 5 mm in the following case:

- If panel temperature exceeds 45°C and high power supply voltage (>27Vdc)
- Use of the input auxiliary supply for current input (terminal M).

Make sure that sufficient air flow is provided for the device avoiding to place raceways or other objects which could obstruct the ventilation slits. Moreover it is suggested to avoid that devices are mounted above appliances generating heat; their ideal place should be in the lower part of the panel. Install the device in a place without vibrations.

Moreover it is suggested to avoid routing conductors near power signal cables (motors, induction ovens, inverters, etc...) and to use shielded cable for connecting signals.

CONNECTIONS

ANALOG INPUT CONNECTIONS

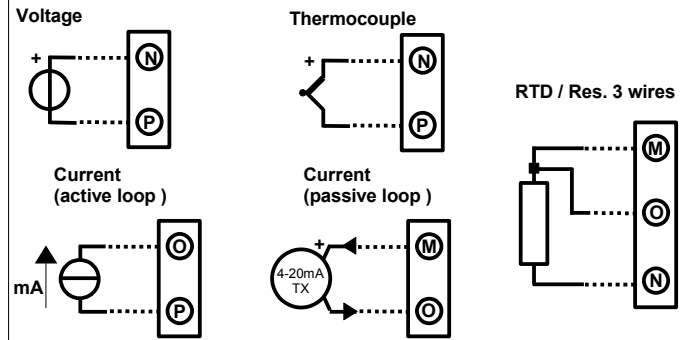

CONTACTS OF RELAYS

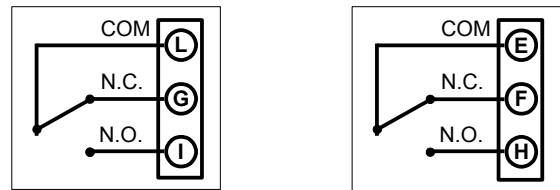

POWER SUPPLY CONNECTIONS

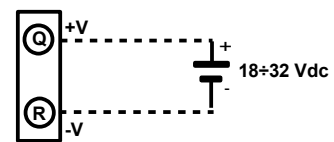

ISOLATION STRUCTURE

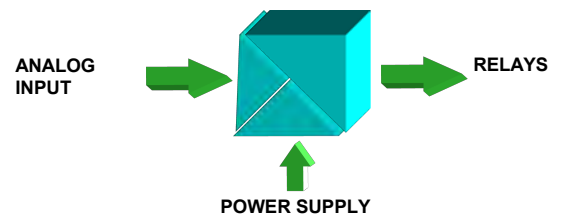

HOW TO ORDER

In phase of order it is necessary to specify the input type (refer to the " Technical Specifications " section) and the number of relays. The DAT5024 is provided as requested on the Customer's order.

ORDER CODE

DAT 5024 - 2 - Pt100 - 100°C - 50°C - MIN - 5% - 2 sec.

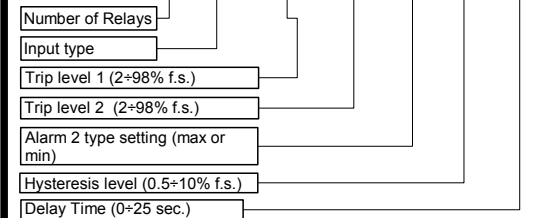

■ = Requested □ = Optional